

Keep with Operator's Manual

**3-POINT HITCH UPPER LINK BRACKET KIT  
95 BACKHOE  
JOHN DEERE TRACTORS**

JOHN DEERE MODELS  
3010, 4010

**TRACTOR AND 3-POINT BRACKET KIT GENERAL INFORMATION**

Three-point bracket kit can be installed using tools ordinarily available. Shut off tractor engine and engage parking brakes during installation.

**MOUNTING BRACKET TO TRACTOR**

**NOTE:** *Install all attaching hardware loosely (unless noted otherwise) until bracket is completely assembled to facilitate assembly and proper alignment.*

1. Remove three-point upper link bracket from tractor. Save all hardware for later use.
2. Fasten three-point bracket (1) to tractor transmission casting using existing hardware.
3. Tighten hardware to torques specified in general torque specifications table (see page 2).
4. When mounting backhoe, attach front center link to three-point bracket (1) using appropriate size bushings, 1.00 x 5-13/16" pin (2) and cotter pins (3).

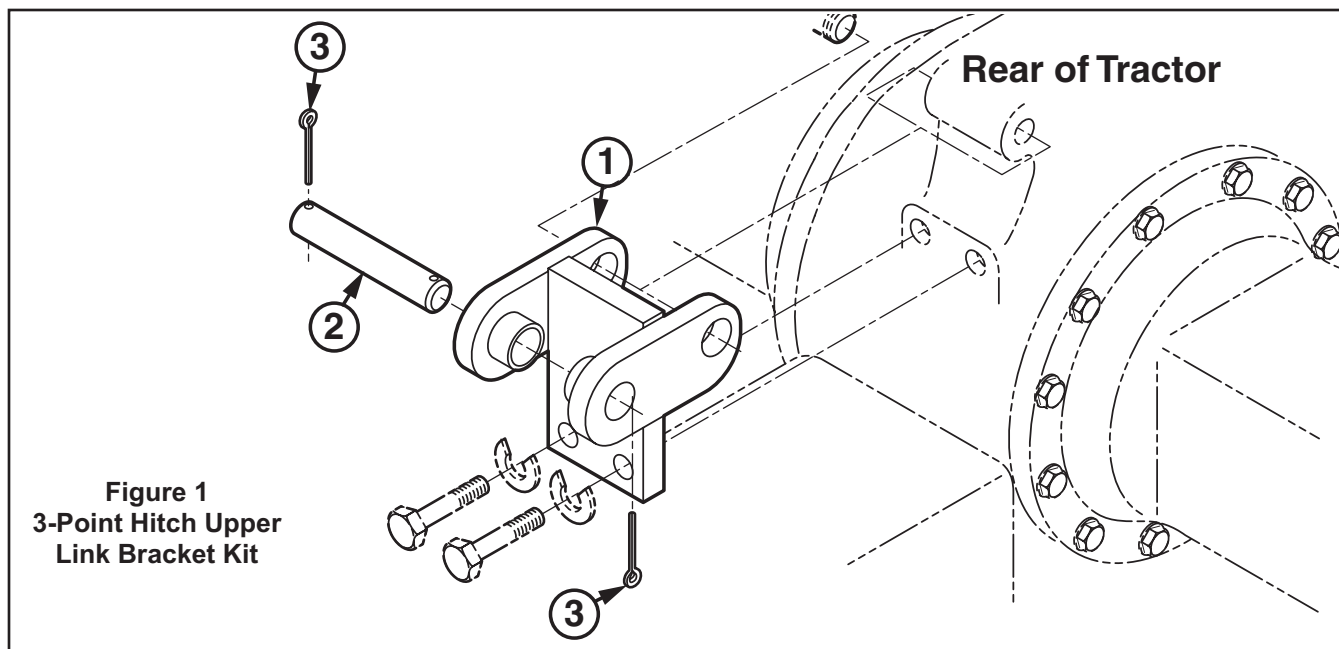

**Figure 1**  
**3-Point Hitch Upper Link Bracket Kit**







**PARTS LIST – 3-POINT HITCH UPPER LINK BRACKET KIT**

Item	Part No.	Description	Qty.
1	46955	BRACKET, Three-Point	1
2	44866-2	PIN, $\varnothing$ 1.00" x 5-13/16"	1
3	41903-9	PIN, Cotter, 3/16 x 2"	2

**GENERAL TORQUE SPECIFICATIONS**

USE THE FOLLOWING TORQUES WHEN SPECIAL TORQUES ARE NOT GIVEN

**Standard American and Metric Cap Screws**

AMERICAN STANDARD CAP SCREWS										METRIC CAP SCREWS							
SAE Grade	5				8				Metric Class	8.8				10.9			
Typ. Head Markings									Typ. Head Markings	 				 			
Cap Screw	TORQUE				TORQUE				Cap Screw	TORQUE				TORQUE			
Size	FT·LBS		N·m		FT·LBS		N·m		Size	FT·LBS		N·m		FT·LBS		N·m	
Inches	MIN	MAX	MIN	MAX	MIN	MAX	MIN	MAX	Millimeters	MIN	MAX	MIN	MAX	MIN	MAX	MIN	MAX
1/4 - 20	6.25	7.25	8.5	10	8.25	9.5	11	13	M6 x 1.00	6	8	8	11	9	11	12	15
1/4 - 28	8	9	11	12	10.5	12	14	16	M8 x 1.25	16	20	21.5	27	23	27	31	36.5
5/16 - 18	14	15	19	20	18.5	20	25	27	M10 x 1.50	29	35	39	47	42	52	57	70
5/16 - 24	17.5	19	23	26	23	25	31	34	M12 x 1.75	52	62	70	84	75	91	102	123
3/8 - 16	26	28	35	38	35	37	47.5	50	M14 x 2.00	85	103	115	139	120	146	163	198
3/8 - 24	31	34	42	46	41	45	55.5	61	M16 x 2.50	130	158	176	214	176	216	238	293
7/16 - 14	41	45	55.5	61	55	60	74.5	81	M18 x 2.50	172	210	233	284	240	294	325	398
7/16 - 20	51	55	69	74.5	68	75	92	102	M20 x 2.50	247	301	335	408	343	426	465	577
1/2 - 13	65	72	88	97.5	86	96	116	130	M22 x 2.50	332	404	450	547	472	576	639	780
1/2 - 20	76	84	103	114	102	112	138	152	M24 x 3.00	423	517	573	700	599	732	812	992
9/16 - 12	95	105	129	142	127	140	172	190	M27 x 3.00	637	779	863	1055	898	1098	1217	1488
9/16 - 18	111	123	150	167	148	164	200	222	M30 x 3.00	872	1066	1181	1444	1224	1496	1658	2027
5/8 - 11	126	139	171	188	168	185	228	251	<p><b>NOTE:</b> These values apply to fasteners as received from supplier, dry or when lubricated with normal engine oil. They do not apply if special graphite or moly sulphide greases or other extreme lubricants are used.</p>								
5/8 - 18	152	168	206	228	203	224	275	304									
3/4 - 10	238	262	322	355	318	350	431	474									
3/4 - 16	274	305	371	409	365	402	495	544									
7/8 - 9	350	386	474	523	466	515	631	698									
7/8 - 14	407	448	551	607	543	597	736	809									
1 - 8	537	592	728	802	716	790	970	1070									
1 - 14	670	740	908	1003	894	987	1211	1337									

# INSTALLATION INSTRUCTIONS