

Keep with Operator's Manual

SINGLE-HANDLE CONTROL VALVE & PLUMBING KIT (SERIES VALVE) 2406 LOADER KUBOTA TRACTORS

MODEL	ROPS
B1550HSD, B1750HSD	X
B6200DT, B6200HSD	X
B7100HSD, B7200DT	X

VALVE AND PLUMBING GENERAL INFORMATION

This kit includes a series valve. A series valve may be preferred over a parallel valve because of relative ease with which two functions can be performed simultaneously. However, attempting to simultaneously lift and roll back will cause a reduction in power and, eventually, a stall. To prevent this, a shield (17 Figure 1) is installed onto valve, which will allow lift or roll back, but not both simultaneously. It is important that this shield (17) be in place at all times to assure maximum loader efficiency. This shield also displays important safety (19) and operation decals (18 & 20) which must be visible and legible on valve at all times.

NOTE: Valve handle is equipped with a spool lock/unlock feature. Spool lock/unlock operation decal (20) near handle boot (5) shows how to operate small knob at base of handle linkage to allow or prevent handle operation. (See Figure 1.)

Pulling small knob outward and turning it a quarter-turn to hold it out, allows handle operation.

Pulling small knob, turning it a quarter turn, and allowing spring to retract it to inward position locks handle to prevent operation.

Valve and plumbing kit can be installed on tractor using tools ordinarily available. Shut off engine and engage brakes during installation.

NOTE: Apply sealant only to all tapered threads unless coupled with swivel adapters. When using teflon tape, wrap tape clockwise (as viewed from end) and wrap only twice. Keep sealant away from first two threads of tapered end to prevent contamination of hydraulic fluid. Do not use sealant on o-ring or flare adapter threads.



WARNING: Escaping hydraulic fluid under pressure can penetrate skin causing serious injury.

- **DO NOT** use your hands to check for leaks. Use a piece of cardboard or paper to search for leaks.
- Stop engine and relieve pressure before connecting or disconnecting lines.
- Tighten all connections before starting engine or pressurizing lines.

If any fluid is injected into skin, obtain medical attention immediately or gangrene may result.

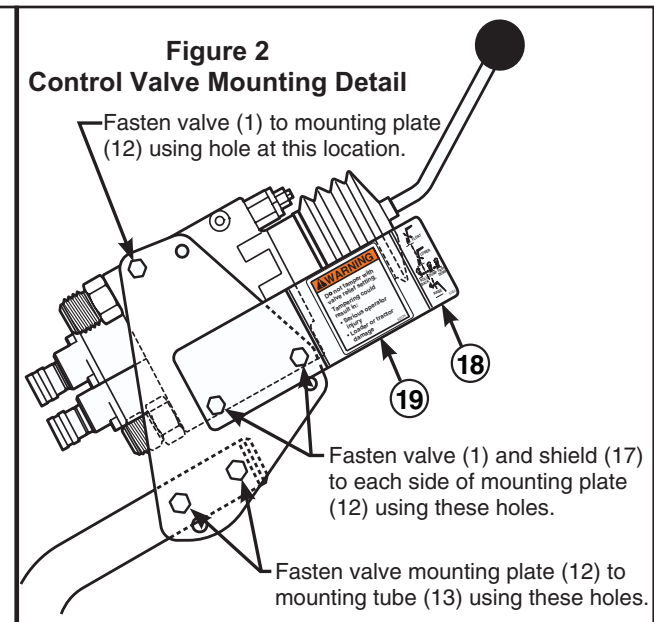
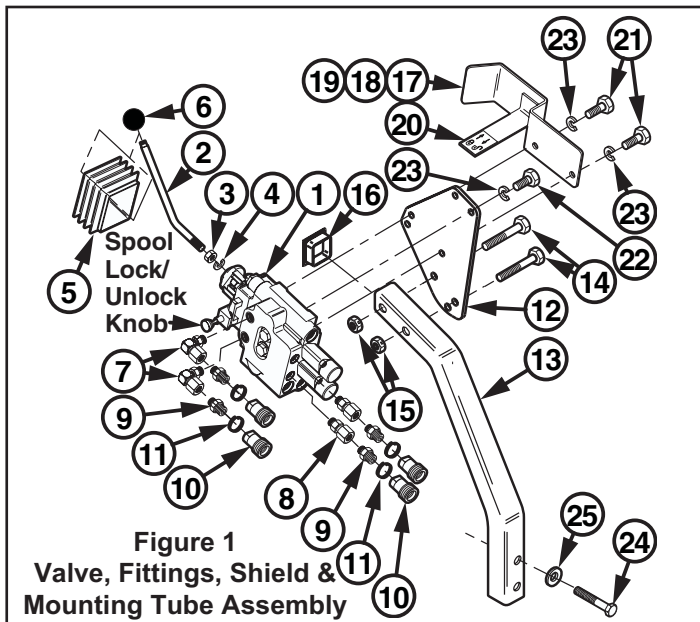

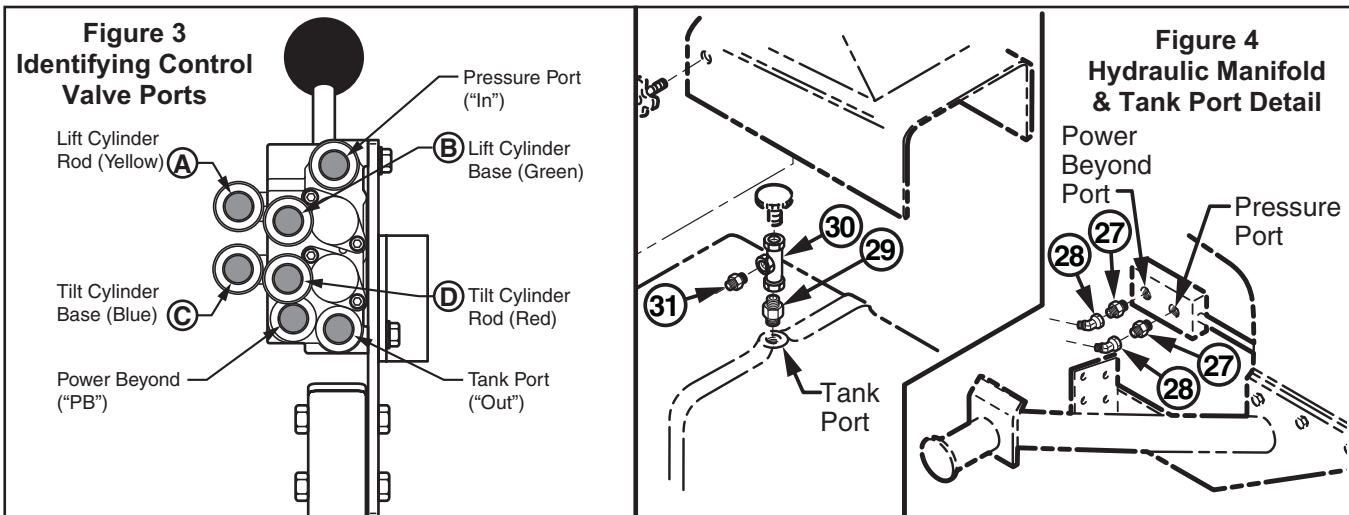

ATTACHING VALVE TO LOADER MOUNTING BRACKETS (Figures 1, 2, 3 & 5)

1. Install 9/16 x 9/16 x 90° elbow fittings (7) into working ports A and C of valve (1). Orient elbow fittings (7) parallel with valve body to point in same direction as valve ports B and D, then tighten jam nuts to lock elbows in position. Install 9/16 x 9/16 straight fittings (8) into working ports B and D of valve (1). Install 9/16 x 3/8 straight fittings (9) into fittings (7 & 8) and install female quick couplers (10) and large identification bands (11) onto straight fittings (9).

NOTE: Be sure to attach color-coded identification bands (11) in sequence shown in Figure 3.

2. Fasten valve mounting plate (12) to valve mounting tube (13) using 3/8 x 2-1/4" cap screws (14) and lock nuts (15). Insert square plug (16) into top of valve mounting tube (13).
3. Fasten valve (1) to valve mounting plate (12) with tank and power beyond ports to bottom using 5/16 x 3/4" cap screw (22) and lock washer (23) in top, front mounting hole in valve. Fasten valve shield (17) to valve (1) through mounting plate (12) using 5/16 x 1" cap screws (21) and lock washers (23) in bottom two mounting holes in valve.

NOTE: Decals (18, 19 & 20) are affixed to valve shield (17) from factory. (See Figure 2.) Replace decals if they become worn or illegible. When applying replacement decals, make sure surface of valve shield (17) is clean and dry.

4. Thread 7/16" nut (3) onto valve handle (2) and place 7/16" lock washer (4) onto handle. Attach handle (2) to valve (1). Slip boot (5) over handle to cover handle linkage assembly. Thread ball (6) onto end of valve handle.

NOTE: To allow valve handle to be adjusted to best position for operator, leave nut (3) with lock washer (4) loose for adjustment until valve and mounting tube is secured to loader right mounting bracket. Tighten nut (3) and secure valve handle boot (5) with plastic tie strap (provided with valve handle and boot) only after valve and plumbing assembly is complete.

5. Attach valve mounting tube (13) to right loader mid mounting bracket using 1/2 x 2-1/2" cap screws (24), flat washers (25), and lock nuts (26).

NOTE: Use outer pair of holes in loader mid mounting bracket when mounting valve on B1750HSD tractor only. Use inner pair of holes in loader mid mounting bracket for all other tractor models.

PLUMBING CONTROL VALVE TO TRACTOR HYDRAULICS (Figures 3, 4 & 5)

1. Remove plugs from tractor hydraulic manifold. Install 3/8 x 9/16 straight adapter fittings (27) into both ports of tractor hydraulic manifold. Install 9/16 x 9/16 x 45° elbow fittings (28) onto 3/8 x 9/16 straight fittings (27).
2. Temporarily remove tractor seat, seat bracket, and shield in front of seat bracket, saving attaching hardware for re-use. Remove and save oil fill plug. Install 1/2" close pipe nipple (29) in place of oil plug, install 1/2 x 1/2 x 1/2 pipe tee (30), with tee stem pointing to right, and install 9/16 x 1/2 straight fitting (31) into stem of tee (30). Install oil fill plug into tee (30) branch, which is pointing upward.

PLUMBING CONTROL VALVE TO TRACTOR HYDRAULICS (Continued)

3. Install 3/8 x 60" hose (33) to tank port of valve (1), install 3/8 x 36" hose (34) to pressure port of valve (1), and install 3/8 x 34" hose (35) to power beyond port of valve (1). Mark opposite end of each hose to identify tank, pressure, and power beyond hose.
4. Slide one 60" hose sleeve (36) over tank hose (33), slide one 38" hose sleeve (37) over pressure hose (34), and slide remaining 38" hose sleeve (37) over power beyond hose (35), securing sleeves over hose crimps with plastic tie strap (38).
5. Route hoses (33, 34 & 35) in sleeves (36 & 37) down from valve (1) along valve mounting tube (13), over loader mid mounting bracket, to tractor hydraulic manifold. Connect 3/8 x 34" power beyond hose (35) to 9/16 x 9/16 x 45° elbow fitting (28) at power beyond (rear) port of tractor hydraulic manifold. Connect 3/8 x 36" pressure hose (34) to 9/16 x 9/16 x 45° elbow fitting (28) at pressure (front) port of tractor hydraulic manifold.
6. Continue routing tank hose (33) in sleeve (36) back along tractor foot platform to 9/16 x 1/2" straight fitting (31) in stem of pipe tee (30) (tractor tank port). Connect 3/8 x 60" tank hose (33) to 9/16 x 1/2" straight fitting (31).
7. Clip plastic trim (32) onto rear right edge of shield, which was removed earlier, to prevent edge from abrading tank hose (33) or sleeve (36), then reinstall shield, seat bracket and seat, using original hardware.
8. Use plastic tie straps (38) to secure hose sleeves (36 & 37) over crimps at ends of hoses (33, 34 & 35) to fittings (28 & 30) and secure hoses and sleeves away from moving parts.

PLUMBING LOADER TO CONTROL VALVE (Figures 3 & 5)

1. Install 1/4 x 60" hoses (39) onto boom oil line tubes. (See Figure 5.) Install and tighten hose fittings one at a time from the bottom up. Loosening closest oil line clamp will ease installation.
2. Install small identification bands (41) onto free ends of hoses (39) to match bands on female quick couplers (10). Slide 60" hose sleeves (36) over hoses (39). Install male quick couplers (40) onto free ends of hoses (39).
3. Connect hoses (39) from upper two boom oil lines to lower female quick couplers on valve and connect hoses (39) from lower two boom oil lines to upper female quick couplers on valve. Wrap tarp strap (42) around hoses (39) and hook on itself. Attach free end of rubber strap to loader right side frame. (See Figure 5.)
4. After all plumbing has been completed, slowly cycle lift and bucket cylinders several times to purge air from hydraulic system. Retract cylinders and shut off tractor engine. Replenish tractor hydraulic system.

NOTE: When cycling loader, operate loader according to operation decal (18) on valve shield (17). If direction of control lever is wrong or loader will not lower, recheck connections shown.



WARNING: Escaping hydraulic fluid under pressure can have sufficient force to penetrate skin causing serious personal injury. If injured by escaping hydraulic fluid, obtain medical treatment immediately.

2-7383

PARTS LIST – VALVE & PLUMBING KIT

Item	Part No.	Description	Qty.
*1	52206	VALVE, Prince LVS, Series, 2-Spool (1800 PSI)	1
*2	43517	HANDLE, Valve, Standard	1
*3	41836-14	NUT, Hex, 7/16-20	1
*4	41837-4	WASHER, Lock, 7/16"	1
*5	52172	BOOT, Valve Handle Linkage	1
*6	38902	BALL, Valve Handle	1
7	44277-2	FITTING, Elbow, 90°, 9/16-18 SAE O-Ring Male x 9/16-18 JIC Female	2
8	42062-6	FITTING, Straight, 9/16-18 SAE O-Ring Male x 9/16-18 JIC Female	2
9	31221-4	FITTING, Straight, 3/8 NPT Male x 9/16-18 JIC Male	4
10	6147-4	COUPLER, Female Quick, 3/8"	4
11	36240-9	SPIRAL BAND, Plastic, Blue, 1"	1
	36240-10	SPIRAL BAND, Plastic, Red, 1"	1
	36240-11	SPIRAL BAND, Plastic, Yellow, 1"	1
	36240-12	SPIRAL BAND, Plastic, Green, 1"	1
12	52201	PLATE, Valve Mounting	1
13	44366	TUBE, Valve Mounting	1
14	41838-19	SCREW, Cap, 3/8-16 x 2-1/4"	2
15	41840-3	NUT, Lock, 3/8-16	2
16	44274-1	PLUG, Square Tube	1
17	52189	SHIELD, Series Valve, With Decals	1
18	52204	DECAL, Single Handle Control	1
19	52074	DECAL, WARNING: Do Not Tamper With Valve Relief Setting	1
20	52203	DECAL, Lock/Unlock	1
21	41838-60	SCREW, Cap, 5/16-18 x 1"	2
22	41838-26	SCREW, Cap, 5/16-18 x 3/4"	1
23	41837-2	WASHER, Lock, 5/16"	3
24	41838-25	SCREW, Cap, 1/2-13 x 2-1/2"	2
25	42502-10	WASHER, Flat, 1/2"	2
26	41840-5	NUT, Lock, 1/2-13	2
27	36249-1	FITTING, Straight, 3/8 BSPP O-Ring Male x 9/16-18 JIC Male	2
28	38226-1	FITTING, Elbow, 45°, 9/16-18 JIC Male x 9/16-18 JIC Female Swivel	2
29	44982-3	NIPPLE, Pipe, Close, 1/2" NPT	1
30	23250-2	FITTING, Tee, Pipe, Female, 1/2-14 NPT	1
31	6036-4	FITTING, Straight, 9/16-18 JIC Male x 1/2-14 NPT	1
32	24765-3	PLASTIC TRIM, 2"	1
33	43454-3	HOSE, 3/8 x 60", 3/4-16 O-Ring Male x 9/16-18 JIC Female Swivel (Tank)	1
34	43454-2	HOSE, 3/8 x 36", 3/4-16 O-Ring Male x 9/16-18 JIC Female Swivel (Pressure)	1
35	43454-16	HOSE, 3/8 x 34", 3/4-16 O-Ring Male x 9/16-18 JIC Female Swivel (Power Beyond)	1
36	34853-34	SLEEVE, Hose, 60" Long	5
37	34853-33	SLEEVE, Hose, 38" Long	2
38	8137-1	STRAP, Plastic, Adjustable, 3/16" wide x 11" long	5
39	36251-3	HOSE, 1/4 x 60", 9/16-18 JIC Female Swivel x 3/8 NPTF Male (Loader Control)	4
40	6137-4	COUPLER, Male Quick, 3/8	4
41	36240-5	SPIRAL BAND, Plastic, Blue, 5/8"	1
	36240-6	SPIRAL BAND, Plastic, Red, 5/8"	1
	36240-7	SPIRAL BAND, Plastic, Yellow, 5/8"	1
	36240-8	SPIRAL BAND, Plastic, Green, 5/8"	1
42	7438-1	TARP Strap	1

* Items 2 through 6 are included with valve, item 1.

Figure 5
Plumbing Control Valve
to Loader and
Tractor Hydraulics

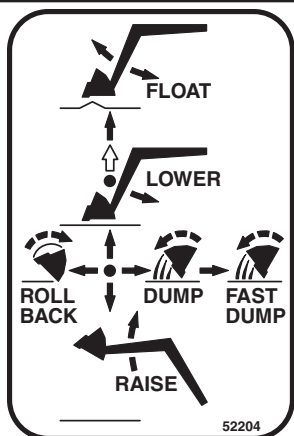
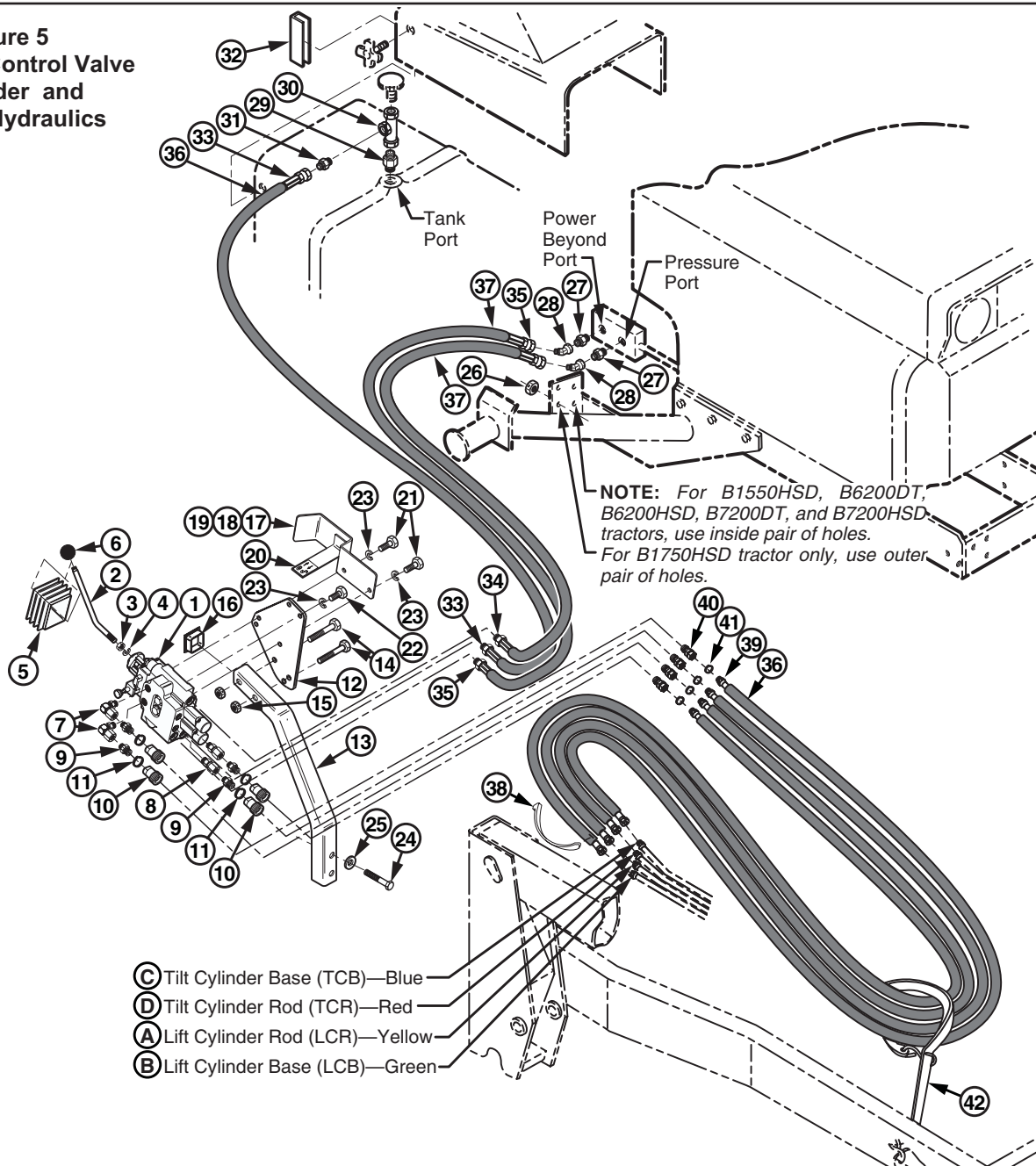

52204 — Item 18
Single Handle Control Decal



52074 — Item 19
Warning Decal
Do Not Tamper

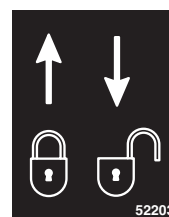

52203 — Item 20
Operation Decal
Spool Lock/Unlock

PRINCE LVS (SERIES) VALVE SERVICE (Figure 6)

Following is an outline procedure for disassembling and reassembling valve.



WARNING: *This valve has a valve relief setting preset at the factory. Tampering with this setting can cause serious injury to operator and damage to tractor, valve, or loader. Unauthorized adjustments or service to valve relief will VOID WARRANTY of both loader and tractor. If adjustments or service to valve relief are required during warranty period, an authorized service department must be consulted for authorization.*

VALVE HANDLE DISASSEMBLY

NOTE: *It is advisable to mark or tag all parts so they will be reinstalled in their proper position.*

1. Remove ball (23, Figure 6) from valve handle (19) by twisting ball (23) counterclockwise, unthreading it from handle (19).
2. Remove tie strap (24) and slide boot (22) off end of valve handle (19) to remove boot (22) and expose linkage components.
3. Remove handle (19) from linkage disk (25) by unjamming 7/16" hex nut (20) and lock washer (21) from linkage disk (25), then unthreading handle (19) from disk (25).
4. Remove three 5/16-24 x 3/4" socket head cap screws (26) to remove handle linkage disk (25) from rod ends (27 & 28). Remove 5/16-24 hex nuts (30) from spool stud (29) and rod end assemblies (27) to remove spool stud (29) and rod end assemblies (27) from spool ends.

NOTE: *Handle linkage parts, 5/16 x 3/4" socket head cap screws (26) and 5/16-24 hex nuts (30), have been assembled using Loctite® 680 or equivalent.*

NOTE: *Valve spools are one-piece construction. Spool ends are not separable from spools.*

5. Remove clevis housing (31) and spool lock assembly from valve by removing two 1/4 x 1-3/4" socket head cap screws (32) and one 1/4 x 3/4" socket head cap screw (33) with flat washer (34).

NOTE: *1/4" socket head cap screws (32 & 33), which fasten clevis housing (31) to valve body, have been assembled using Loctite 680 or equivalent.*

6. Remove spool lock assembly from clevis housing (31) by removing retaining ring (38) and sliding handle (36) away from valve, taking care to not lose spring (39). Remove lock blade (37). Unthread knob (35) to remove it from handle (36). Remove 1/8 x 3/4" spring pin (40) with a hammer and pliers.

RELIEF VALVE AND LOAD CHECK PLUGS

NOTE: *Relief valve (2) and load check plugs (3) may be removed separately to clean, inspect, or replace parts, without removing valve spools.*

NOTE: *If repairing or replacing relief valve (2), torque larger hex nut (relief body) to 20-25 ft.·lbs. If repairing or replacing load check plugs (3), torque to 20-25 ft.·lbs.*

SPOOL POSITIONER DISASSEMBLY

Positioner assemblies (4 & 5) for float and regen spools are nearly identical, with the exception of positioning sleeve (8 & 9), for which float spool requires a float detent sleeve (8, which has an internal groove for detent hold) and the regen spool requires a regen detent sleeve (9, which has a smooth bore with a step). The same procedure describes how to disassemble both positioners.

1. Remove socket head cap screws (6) and detent end caps (7) from both spools. Being careful not to lose small spring-loaded parts, steel balls (13), poppet (11), and spring (12), remove detent sleeve (8 & 9) from each spool.



CAUTION: *Compression spring (12) maintains pressure on poppet (11), which in turn maintains pressure on steel balls (13), which are all held within detent retainer (10) by detent sleeve (8 or 9). Steel balls (13), poppet (11) and spring (12) may spring out when detent sleeve (8 or 9) is removed. Wear safety glasses.*

2. Remove steel balls (13), poppet (11), and poppet spring (12) from detent retainer (10). Remove retainer flat (14) and detent spacer (15) for each spool.
3. Secure handle end of each spool and, using a rod through retainer ball holes, remove detent retainer (10) from each spool.

NOTE: *Detent retainers (10) are installed on spools using Loctite 222 or equivalent.*

4. Remove washer (16), centering spring (17) and stop cup (18) from each spool.

SPOOL SEAL REMOVAL

To remove spool seals (1), push spool in until seal (1) is exposed. Use a wire hook and screwdriver to remove exposed spool seals.

NOTE: *Removing or replacing spool seals near handle ends of valve spools will destroy spool seals near positioner ends. Replace positioner-end spool seals after replacing handle-end spool seals.*

BEFORE REASSEMBLING

Clean all parts, including valve body, in a suitable cleaning solvent. After cleaning parts with solvent, use air pressure to blow any dirt or excess solvent from all parts, including valve body. Examine all parts for wear or damage and replace if necessary.

VALVE REASSEMBLY

Reassemble all parts in reverse order of disassembly.

1. Lubricate all o-rings and spools with oil to prevent damage when assembling.

NOTE: *When replacing spool seals (1), install seal in handle end first and then replace seal in positioner end.*

2. Lubricate all detent and spring centering parts with a light coat of grease when assembling.

NOTE: *When fastening detent retainers (10) onto valve spools, clean threads thoroughly and install with Loctite 222 or equivalent, following instructions provided with thread locking compound, and tighten to 5-7 ft.·lbs.*

When installing detents, install spring (12) and poppet (11) into detent retainer (10) and compress spring (12). Install steel balls (13) and slide detent sleeve (8 or 9) over detent retainer (10), capturing steel balls (13).

NOTE: *For proper valve operation, float detent sleeve (8) must be installed onto detent retainer for float spool, and regen detent sleeve (9) must be installed on detent retainer for regen spool. Float detent sleeve (8) has an internal groove for detent hold. Regen detent sleeve (9) has a smooth bore with a step. Refer to Figure 6 for location of float spool and regen spool.*

NOTE: *When fastening 5/16" and 1/4" hardware for clevis housing and handle linkage, clean all threads thoroughly with alcohol, apply Loctite primer T, and install with Loctite 680, following instructions provided with thread locking compound. Tighten 1/4" hardware (coarse thread) to 110 in.·lbs. and tighten 5/16" hardware (fine thread) to 170-190 in.·lbs.*

2-7383

PARTS LIST – PRINCE LVS (SERIES) VALVE

Item	Part No.	Description	Qty.
1	52253	SEAL KIT, Prince LVS Valve	1
2	43637-4	RELIEF VALVE (1800 PSI)	1
3	52255	PLUG, Load Check	2
4	52254	FLOAT KIT (Includes items 6, 7, 8, 10, 11, 12, 13, 14, 15, 16, 17, and 18)	1
5	52255	REGEN KIT (Includes items 6, 7, 9, 10, 11, 12, 13, 14, 15, 16, 17, and 18)	1
7	44476-5	END CAP, Manufacturer's part number (HC-V-AA24) stamped on end cap identifies valve and relief setting.	2
19	43517	HANDLE, Valve, Standard	1
20	41836-14	NUT, Hex, 7/16-20	1
21	41837-4	WASHER, Lock, 7/16"	1
22	52172	BOOT, Rubber, Valve Handle	1
23	38902	BALL, Handle	1
24	-----	TIE STRAP, 3/16" wide x 13" long	1
25	52251	DISK, Adapter, Handle to Linkage	1
26	44743-4	SCREW, Cap, Socket Head, 5/16-24 x 3/4"	3
27	51075	ROD END, Assembly	2
28	38900-4	ROD END	1
29	51076	STUD, Spool	1
30	41836-12	NUT, Hex, 5/16-24	3
31	52252	CLEVIS, Lock, Housing	1
32	44743-7	SCREW, Cap, Socket Head, 1/4-20 x 1-3/4"	2
33	44743-6	SCREW, Cap, Socket Head, 1/4-20 x 3/4"	1
34	42502-6	WASHER, Flat, 1/4"	1
35	52250	KNOB, Spool Lock	1
36	52247	HANDLE, Spool Lock	1
37	52246	BLADE LOCK	1
38	52249-1	RING, Retaining, External	1
39	52248	SPRING	1
40	G273625	ROLL PIN	1

NOTE: Valve spools are one-piece construction, which includes spool ends for connecting handle linkage. Valve spools and body are matched parts and are not available separately. Individual items not listed in repair parts listing are not available separately.

Figure 6
Prince LVS (Series)
Valve Service

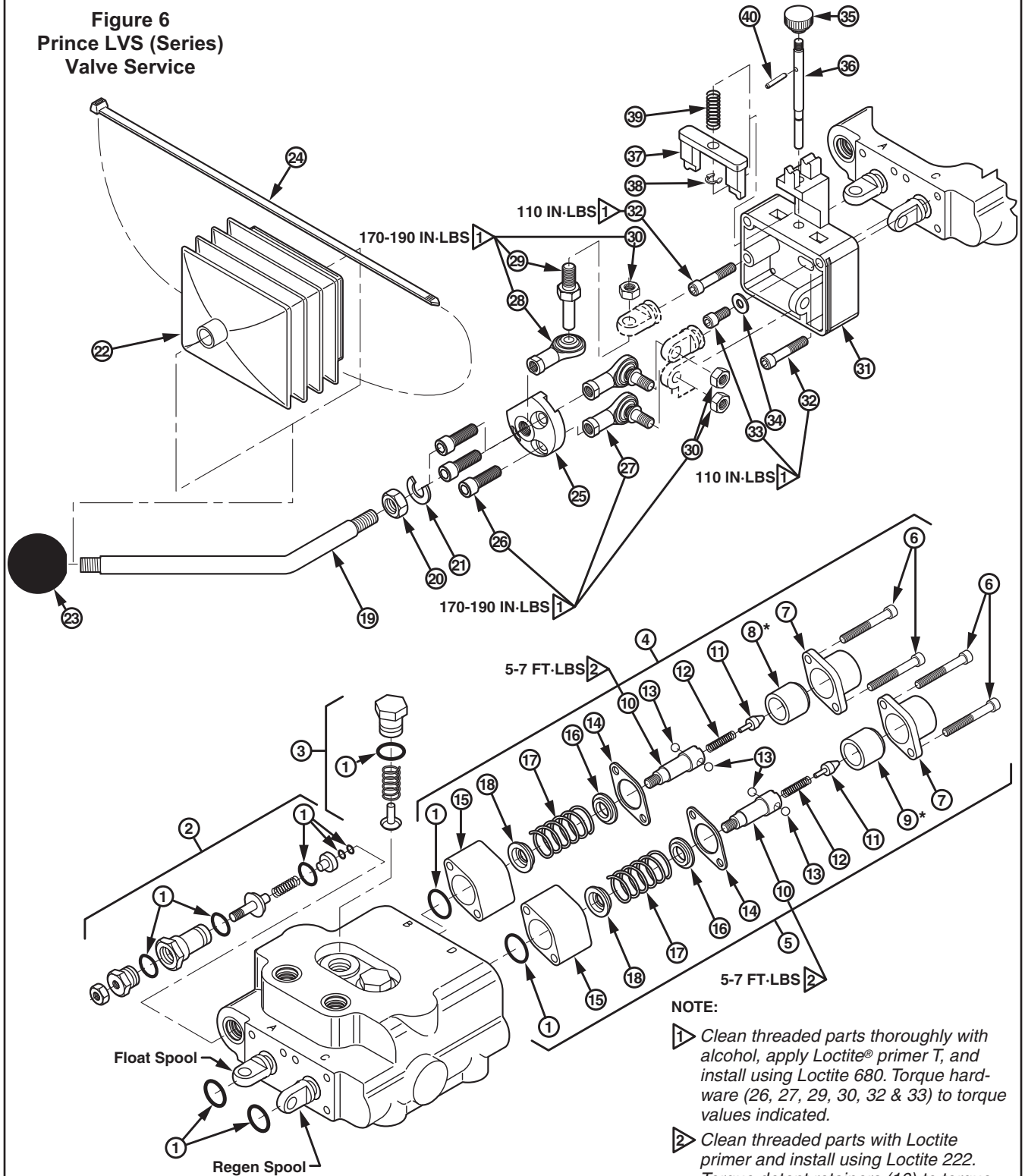

NOTE:







- 1 Clean threaded parts thoroughly with alcohol, apply Loctite® primer T, and install using Loctite 680. Torque hardware (26, 27, 29, 30, 32 & 33) to torque values indicated.
- 2 Clean threaded parts with Loctite primer and install using Loctite 222. Torque detent retainers (10) to torque values indicated.

* Float detent sleeve (8) has an internal groove for detent hold. Regen detent sleeve (9) has a smooth bore with a step.

GENERAL TORQUE SPECIFICATIONS

USE THE FOLLOWING TORQUES WHEN SPECIAL TORQUES ARE NOT GIVEN

Standard American and Metric Cap Screws

AMERICAN STANDARD CAP SCREWS										METRIC CAP SCREWS									
5					8					8.8				10.9					
Typ. Head Markings 					Typ. Head Markings 					Typ. Head Markings  				Typ. Head Markings  					
TORQUE					TORQUE					TORQUE				TORQUE					
Size		FT·LBS		N·m		FT·LBS		N·m		Size		FT·LBS		N·m		FT·LBS		N·m	
Inches	MIN	MAX	MIN	MAX	MIN	MAX	MIN	MAX	MIN	MAX	Millimeters	MIN	MAX	MIN	MAX	MIN	MAX	MIN	MAX
1/4 - 20	6.25	7.25	8.5	10	8.25	9.5	11	13			M6 x 1.00	6	8	8	11	9	11	12	15
1/4 - 28	8	9	11	12	10.5	12	14	16			M8 x 1.25	16	20	21.5	27	23	27	31	36.5
5/16 - 18	14	15	19	20	18.5	20	25	27			M10 x 1.50	29	35	39	47	42	52	57	70
5/16 - 24	17.5	19	23	26	23	25	31	34			M12 x 1.75	52	62	70	84	75	91	102	123
3/8 - 16	26	28	35	38	35	37	47.5	50			M14 x 2.00	85	103	115	139	120	146	163	198
3/8 - 24	31	34	42	46	41	45	55.5	61			M16 x 2.50	130	158	176	214	176	216	238	293
7/16 - 14	41	45	55.5	61	55	60	74.5	81			M18 x 2.50	172	210	233	284	240	294	325	398
7/16 - 20	51	55	69	74.5	68	75	92	102			M20 x 2.50	247	301	335	408	343	426	465	577
1/2 - 13	65	72	88	97.5	86	96	116	130			M22 x 2.50	332	404	450	547	472	576	639	780
1/2 - 20	76	84	103	114	102	112	138	152			M24 x 3.00	423	517	573	700	599	732	812	992
9/16 - 12	95	105	129	142	127	140	172	190			M27 x 3.00	637	779	863	1055	898	1098	1217	1488
9/16 - 18	111	123	150	167	148	164	200	222			M30 x 3.00	872	1066	1181	1444	1224	1496	1658	2027
5/8 - 11	126	139	171	188	168	185	228	251											
5/8 - 18	152	168	206	228	203	224	275	304											
3/4 - 10	238	262	322	355	318	350	431	474											
3/4 - 16	274	305	371	409	365	402	495	544											
7/8 - 9	350	386	474	523	466	515	631	698											
7/8 - 14	407	448	551	607	543	597	736	809											
1 - 8	537	592	728	802	716	790	970	1070											
1 - 14	670	740	908	1003	894	987	1211	1337											

NOTE: These values apply to fasteners as received from supplier, dry or when lubricated with normal engine oil. They do not apply if special graphite or molysulphide greases or other extreme lubricants are used.

37° JIC Fittings

Size	Thread Size	Assembly Torque		Tube Connection F. F. F. T.	Swivel Nut or Hose Connection F. F. F. T.
		in.·lb.	ft.·lb.		
-4	7/16 - 20	140 ± 10	12 ± 1	2	2
-5	1/2 - 20	180 ± 15	15 ± 1	2	2
-6	9/16 - 18	250 ± 15	21 ± 1	1 1/2	1 1/4
-8	3/4 - 16	550 ± 25	45 ± 5	1 1/2	1
-12	1 1/16 - 12	1000 ± 50	85 ± 5	1 1/4	1
-16	1 5/16 - 12	1450 ± 50	120 ± 5	1	1
-20	1 5/8 - 12	2000 ± 100	170 ± 10	1	1
-24	1 7/8 - 12	2400 ± 150	200 ± 15	1	1
-32	2 1/2 - 12	3200 ± 200	270 ± 20	1	1

O-Ring Face Seal Tube/ Hose Swivel Nut

Metric Tube O.D. (mm)	Dash Size	Thread Size (in.)	Swivel Nut Hex Size (in.)	Swivel Nut Torque	
				N·m	lb·ft
5	-3	--	--	--	--
6	-4	9/16 - 18	11/16	16	12
8	-5	--	--	--	--
10	-6	11/16 - 16	13/16	24	18
12	-8	13/16 - 16	15/16	50	37
16	-10	1 - 14	1-1/8	69	51
20	-12	1-3/16 - 12	1-3/8	102	75
22	-14	1-3/16 - 12	--	102	75
25	-16	1-7/16 - 12	1-5/8	142	105
32	-20	1-11/16 - 12	1-7/8	190	140
38	-24	2 - 12	2-1/4	217	160
50.8	-32	--	--	--	--

SAE O-Ring Fittings

Size	Swivel Nut or Hose	Assembly Torque		F. F. F. T.
		in.·lb.	ft.·lb.	
2	5/16 - 24	90 ± 5	7.5 ± 0.5	1 ± .25
3	3/8 - 24	170 ± 10	14 ± 1	1 ± .25
4	7/16 - 20	220 ± 15	18 ± 1	1 ± .25
5	1/2 - 20	260 ± 15	22 ± 1	1 ± .25
6	9/16 - 18	320 ± 20	27 ± 2	1.5 ± .25
8	3/4 - 16	570 ± 25	48 ± 2	1.5 ± .25
10	7/8 - 14	1060 ± 50	90 ± 5	1.5 ± .25
12	1 1/16 - 12	1300 ± 50	110 ± 5	1.5 ± .25
14	1 3/16 - 12	1750 ± 75	145 ± 6	1.5 ± .25
16	1 5/16 - 12	1920 ± 125	160 ± 6	1.5 ± .25
20	1 5/8 - 12	2700 ± 150	225 ± 12	1.5 ± .25
24	1 7/8 - 12	3000 ± 150	250 ± 12	1.5 ± .25
32	2 1/2 - 12	3900 ± 200	325 ± 15	1.5 ± .25

INSTALLATION INSTRUCTIONS